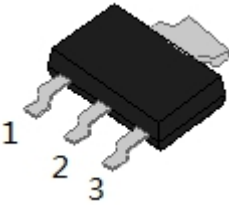
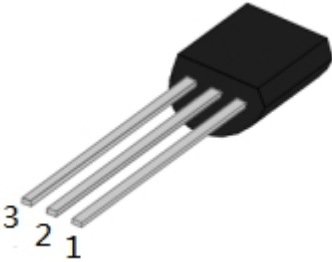
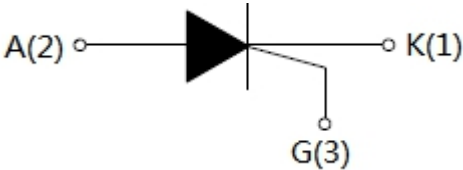

SX014 Series Sensitive gate SCRs

Description

The SX014 SCR series provide high dv/dt rate with strong resistance to electromagnetic interference. They are especially recommended for use on residual current circuit breaker, straight hair, igniter etc.

<p>SX014V</p> 	<p>SX014CR</p> 
SOT-223	TO-92CR
	

Maximum Ratings:

Characteristics	Symbol	Condition	Max.	Units
Storage junction temperature range	T_{stg}	-	-40-150	°C
Operating junction temperature range	T_j	-	-40-110	°C
Repetitive peak off-state voltage ($T_j=25^\circ\text{C}$)	V_{DRM}	-	900	V
Repetitive peak reverse voltage ($T_j=25^\circ\text{C}$)	V_{RRM}	-	900	V
RMS on-state current	$I_{(TRMS)}$	TO-92CR($T_c=50^\circ\text{C}$)	1.25	A
		SOT-223($T_c=75^\circ\text{C}$)		
Non repetitive surge peak on-state current ($t_p=10\text{ms}$)	I_{TSM}	-	20	A
I^2t value for fusing ($t_p=10\text{ms}$)	I^2t	-	2	A ² s
Critical rate of rise of on-state current	di/dt	-	50	A/ μs
Peak gate current ($t_p=20\mu\text{s}$, $T_j=110^\circ\text{C}$)	I_{GM}	-	0.2	A
Peak gate power ($t_p=20\mu\text{s}$, $T_j=110^\circ\text{C}$)	P_{GM}	-	0.5	W
Average gate power dissipation($T_j=110^\circ\text{C}$)	$P_{G(AV)}$	-	0.1	W

Electrical Characteristics($T_j=25^\circ\text{C}$ unless otherwise specified)

Symbol	Condition	Min.	Typ.	Max.	Units
I_{GT}	$V_D=12\text{V}$ $R_L=33\Omega$	20	50	200	μA
V_{GT}		-	0.6	0.8	V
V_{GD}	$V_D=V_{DRM}$ $T_j=110^\circ\text{C}$	0.2	-	-	V
I_L	$I_G=1.2 I_{GT}$	-	-	5	mA
I_H	$I_T=0.05\text{A}$	-	-	4	mA
dV/dt	$V_D=537\text{V}$ $T_j=110^\circ\text{C}$ $R_{GK}=1\text{K}\Omega$	200	-	-	V/ μs

Static Characteristics

Symbol	Condition	Max.	Units
V_{TM}	$I_T=4\text{A}$ $t_p=380\mu\text{s}$ $T_j=25^\circ\text{C}$	1.5	V
I_{DRM}	$V_D=V_{DRM}$ $V_R=V_{RRM}$ $T_j=25^\circ\text{C}$	5	μA
I_{RRM}	$V_D=V_{DRM}$ $V_R=V_{RRM}$ $T_j=110^\circ\text{C}$	100	μA

Thermal Resistances

Symbol	Condition	Value	Units
$R_{th(j-c)}$	Junction to case	TO-92CR	57
		SOT-223	20
			$^\circ\text{C/W}$

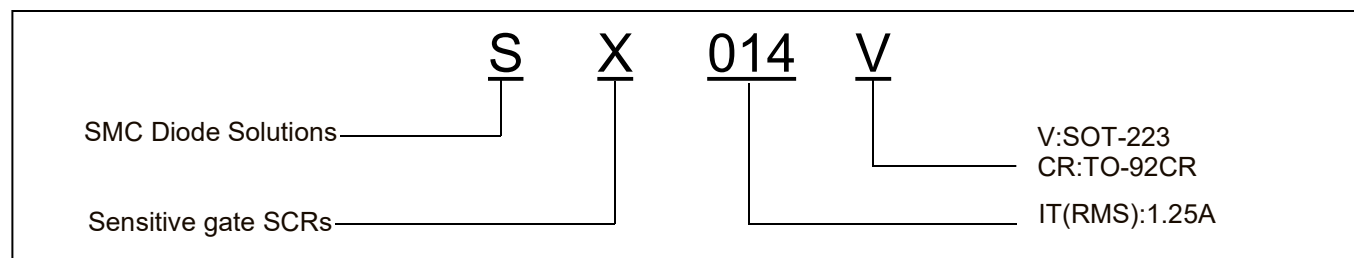
Ordering Information

Device	Package	Shipping
SX014V	SOT-223	4000pcs/ reel
SX014VTR	SOT-223	4000pcs/ reel
SX014CR	TO-92CR	1000pcs/ bag

Ratings and Characteristics Curves

FIG.1: Maximum power dissipation versus RMS on-state current

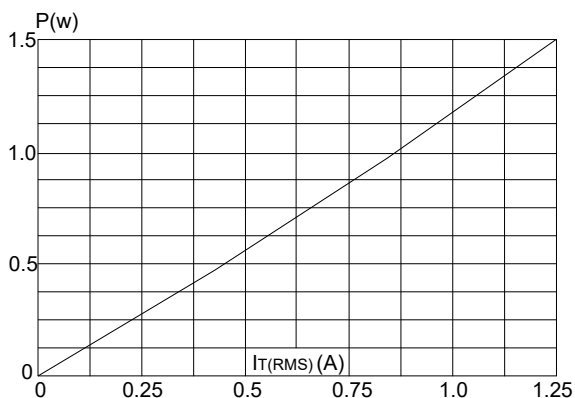

FIG.2: RMS on-state current versus case temperature

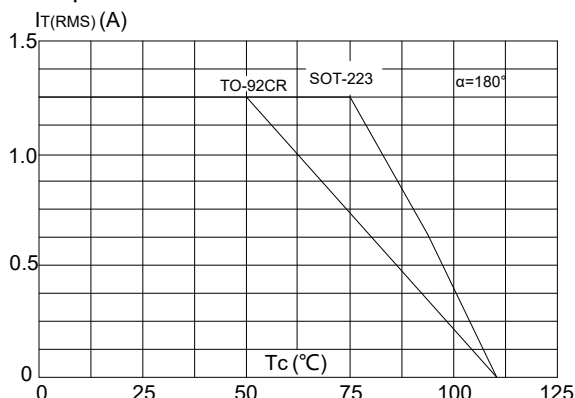

FIG.3: Surge peak on-state current versus number of cycles

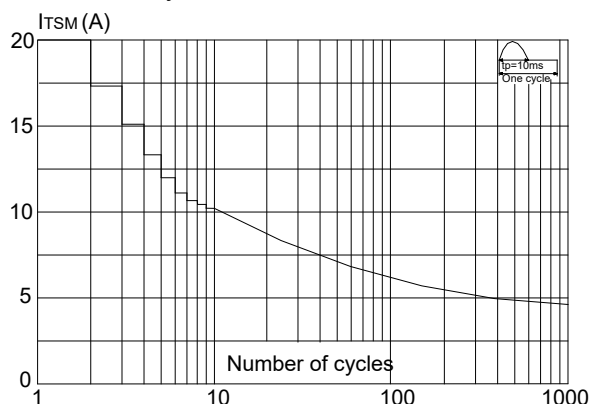

FIG.4: On-state characteristics (maximum values)

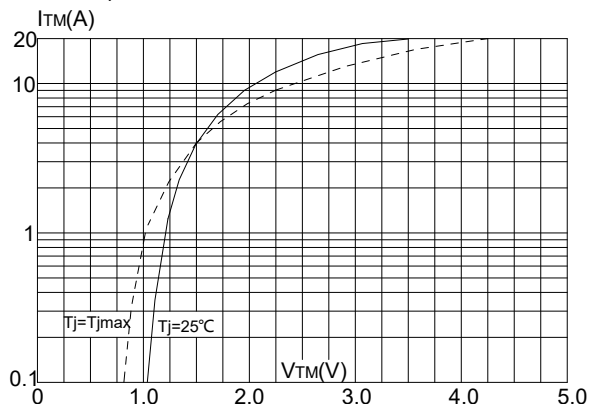

FIG.5: Non-repetitive surge peak on-state current for a sinusoidal pulse with width $t_p < 10ms$, and corresponding value of I^2t ($di/dt < 50A/\mu s$)

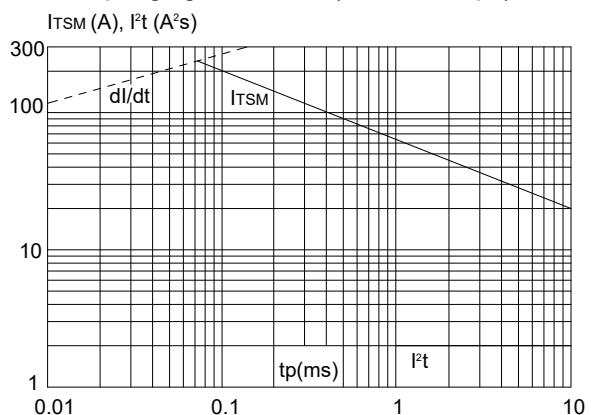
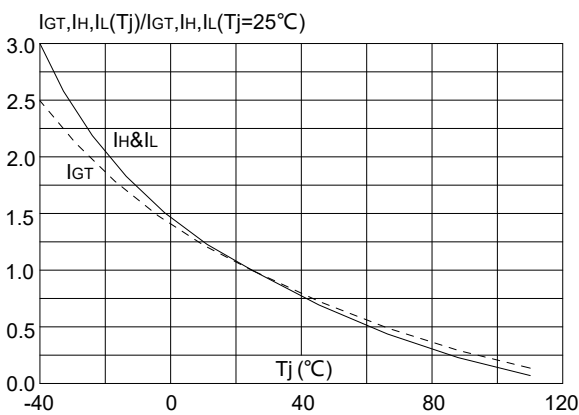
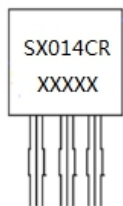

FIG.6: Relative variations of gate trigger current, holding current and latching current versus junction temperature



Marking Diagram



SX014CR

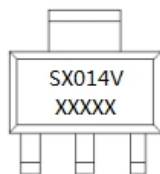

SX014V

Where XXXXX is YYWWL

- S = SMC
- X = Sensitive gate SCRs
- 014 = Forward Current (1A)
- V/CR = Package type
- YY = Year
- WW = Week
- L = Lot Number

Mechanical Dimensions SOT-223

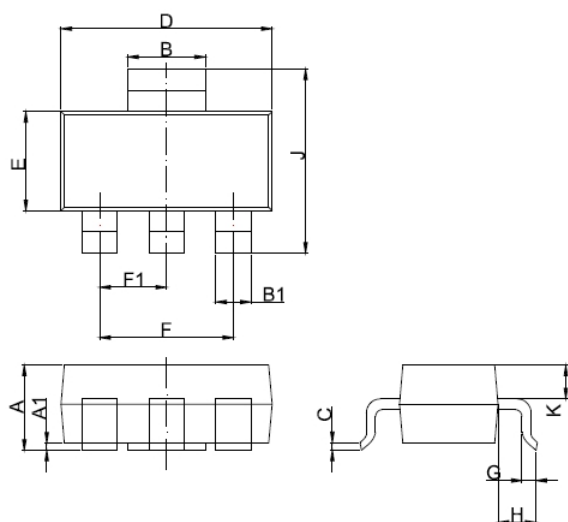

SYMBOL	Millimeters			Inches		
	Min.	Typ.	Max.	Min.	Typ.	Max.
L						
A	1.5	1.6	1.8	0.059	0.063	0.071
A1	0.01	0.06	0.10	0.001	0.002	0.004
B	2.9	3.0	3.1	0.114	0.118	0.122
B1	0.6	0.7	0.8	0.024	0.028	0.031
C	0.22	0.26	0.32	0.009	0.010	0.013
D	6.3	6.5	6.7	0.248	0.256	0.264
E	3.3	3.5	3.7	0.130	0.138	0.146
F		4.6			0.181	
F1		2.3			0.091	
G	0.7	0.9	1.1	0.028	0.035	0.043
H	1.50	1.5	2.0	0.059	0.069	0.079
J	6.7	7.0	7.3	0.264	0.276	0.287
K	0.8	0.9	1.0	0.031	0.035	0.039

Mechanical Dimensions TO-92CR

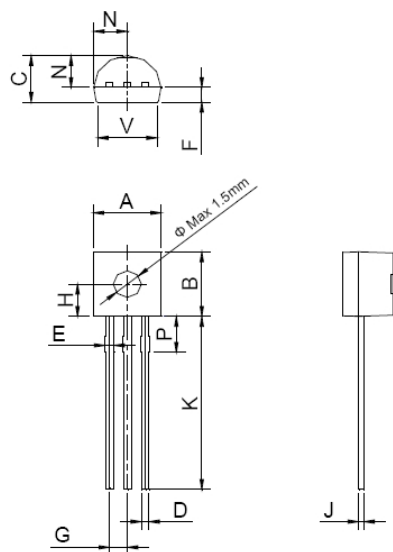

SYMBOL	Millimeters			Inches		
	Min.	Typ.	Max.	Min.	Typ.	Max.
L						
A	4.56	-	5.00	0.179	-	0.197
B	4.56	-	5.00	0.179	-	0.197
C	3.30	-	3.60	0.130	-	0.142
D	0.50	-	0.60	0.020	-	0.024
E	0.60	-	0.80	0.024	-	0.032
F	-	1.1	-	-	0.043	-
G	-	1.27	-	-	0.050	-
H	-	2.43	-	-	0.096	-
J	0.36	-	0.50	0.014	-	0.020
K	11.50	13.00	14.20	0.453	0.512	0.559
N	2.04	-	2.66	0.080	-	0.105
P	2.50	-	2.90	0.098	-	0.114
V	-	-	4.30	-	-	0.169

Technical Data
Data Sheet N2048, Rev.A



DISCLAIMER:

- 1- The information given herein, including the specifications and dimensions, is subject to change without prior notice to improve product characteristics. Before ordering, purchasers are advised to contact the SMC Diode Solutions sales department for the latest version of the datasheet(s).
- 2- In cases where extremely high reliability is required (such as use in nuclear power control, aerospace and aviation, traffic equipment, medical equipment, and safety equipment), safety should be ensured by using semiconductor devices that feature assured safety or by means of users' fail-safe precautions or other arrangement.
- 3- In no event shall SMC Diode Solutions be liable for any damages that may result from an accident or any other cause during operation of the user's units according to the datasheet(s). SMC Diode Solution assumes no responsibility for any intellectual property claims or any other problems that may result from applications of information, products or circuits described in the datasheets.
- 4- In no event shall SMC Diode Solutions be liable for any failure in a semiconductor device or any secondary damage resulting from use at a value exceeding the absolute maximum rating.
- 5- No license is granted by the datasheet(s) under any patents or other rights of any third party or SMC Diode Solutions.
- 6- The datasheet(s) may not be reproduced or duplicated, in any form, in whole or part, without the expressed written permission of SMC Diode Solutions.
- 7- The products (technologies) described in the datasheet(s) are not to be provided to any party whose purpose in their application will hinder maintenance of international peace and safety nor are they to be applied to that purpose by their direct purchasers or any third party. When exporting these products (technologies), the necessary procedures are to be taken in accordance with related laws and regulations..